

TECHNICAL DATA SHEETS

*Closed Impeller 600
Pump Curve Booklet*



TECHNICAL SPECIFICATIONS



ISP Process Pumps - ISP400-600 (500-400-600) ISP Impeller 283935 Closed B93 Z6

Performance Curve - ISP400-600-C-600

600 rpm

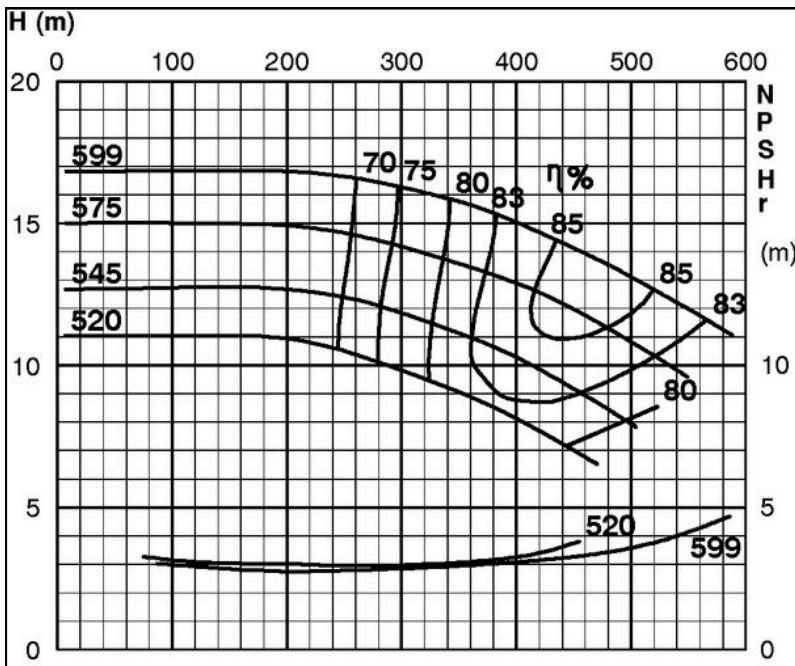

IMPELLER DIA			
$\varnothing d_2$ (mm)	K°	$\varnothing d_a$ (mm)	$\varnothing d_b$ (mm)
599	7	576.5	572.6
595	7	572.0	
590	8	564.0	
585	8	559.0	
580	9	550.0	
575	9	545.0	
570	10	537.0	
565	10	531.0	
560	11	523.0	
555	11	517.0	
550	13	505.0	
545	13	500.0	
540	14	491.0	
535	14	485.0	
530	15	477.0	
525	16	468.0	
520	17	459.0	

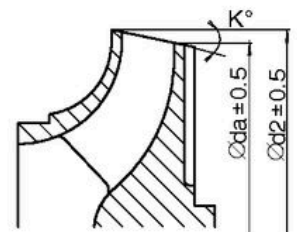
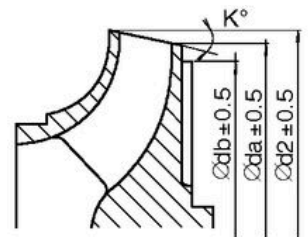
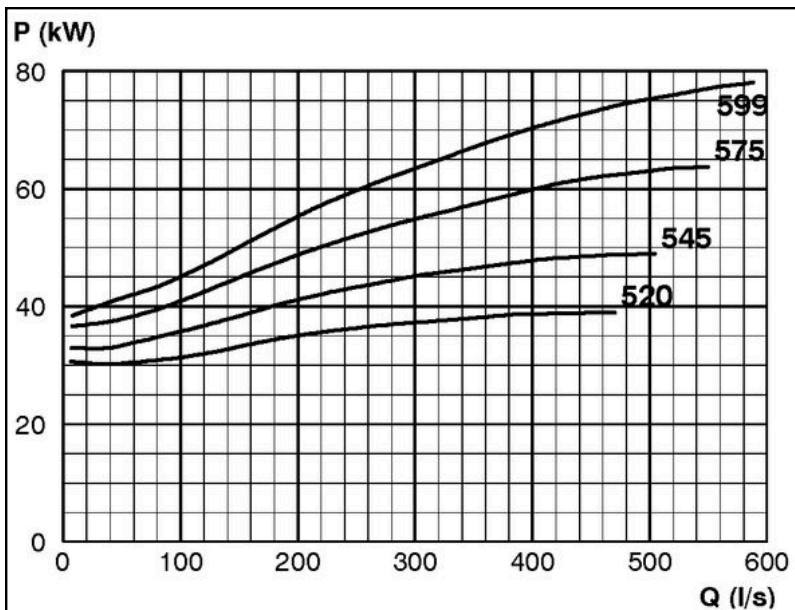

RET14166

TECHNICAL SPECIFICATIONS



ISP Process Pumps - ISP500-600 (500-500-600) ISP Impeller 283936 Closed B114 Z6

Performance Curve - ISP500-600-C-590

590 rpm

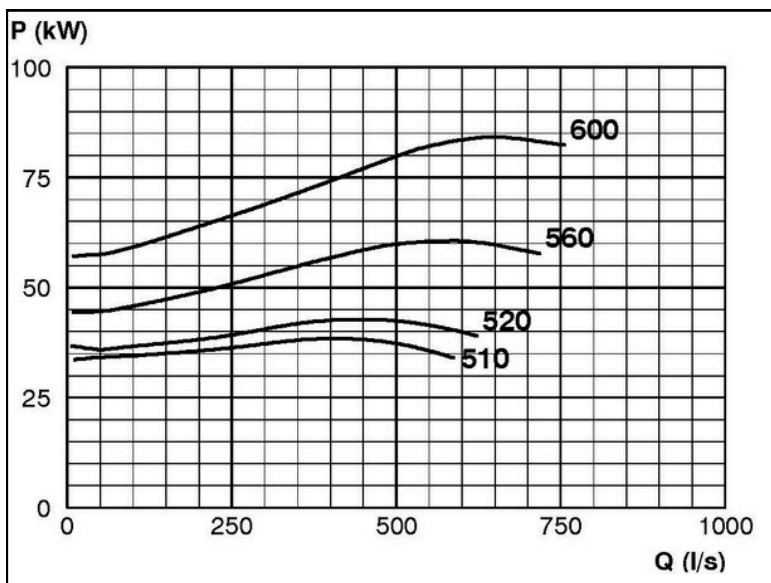
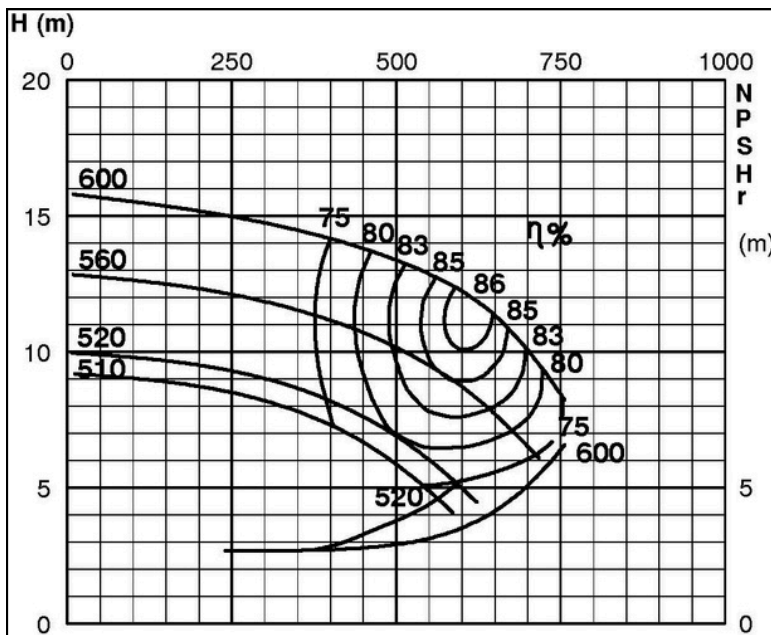

IMPELLER DIA			
Ød ₂ (mm)	K°	Ød _a (mm)	Ød _b (mm)
600	15	541,2	532.7
595	15	536	532.7
590	15	530	
585	15	525	
580	15	519	
575	16	510	
570	16	504	
565	16	498	
560	17	489	
555	17	483	
550	18	478	
545	18	467	
540	19	457	
535	19	451	
530	20	440	
525	20	434	
520	21	423	
515	22	413	
510	23	400	

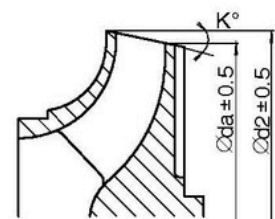
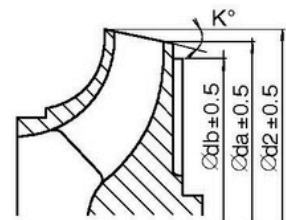

RET14167

TECHNICAL SPECIFICATIONS



ISP Process Pumps - ISP200-600 (300-200-600) ISP Impeller 284004 Closed B35 Z6

Performance Curve - ISP200-600-C-600

600 rpm

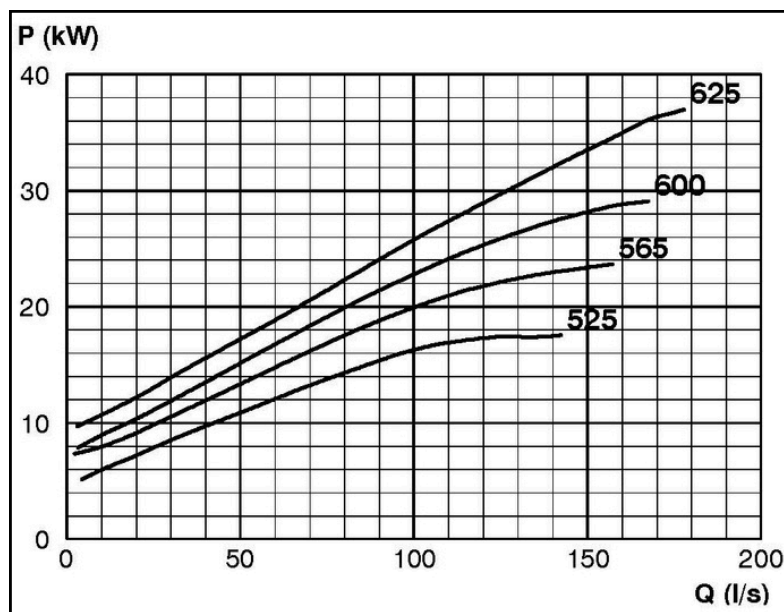
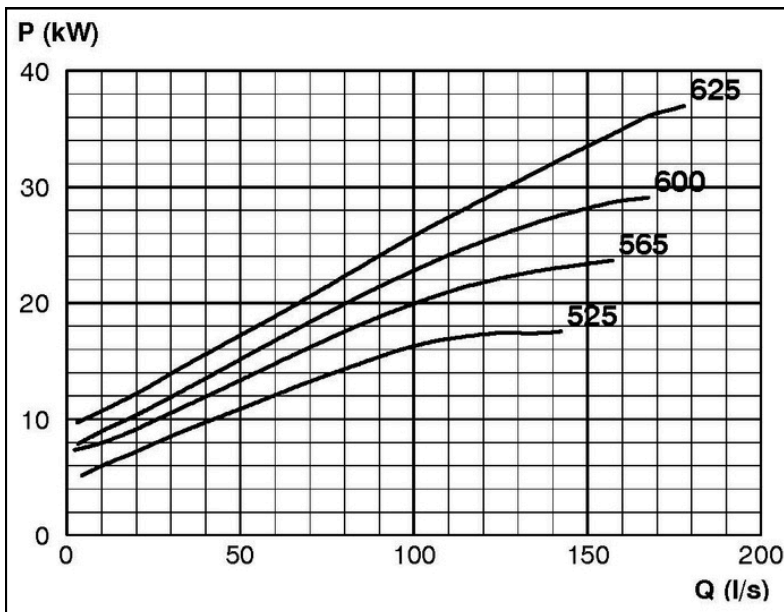

IMPELLER DIA	
$\varnothing d_2$ (mm)	$\varnothing d_b$ (mm)
625	539
620	538
615	533
610	529
605	525
600	522
595	519
590	517
585	514
580	512
575	509
570	505
565	504
560	503
555	500
550	499
545	497
540	495
535	492
530	488
525	485

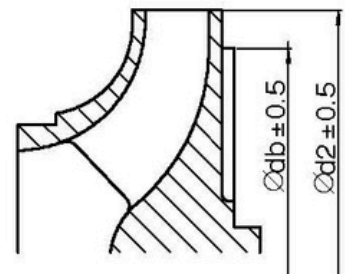

RET14168

TECHNICAL SPECIFICATIONS



ISP Process Pumps - ISP250-600 (300-250-600) ISP Impeller 284005 Closed B43 Z6

Performance Curve - ISP250-600-C-600

600 rpm

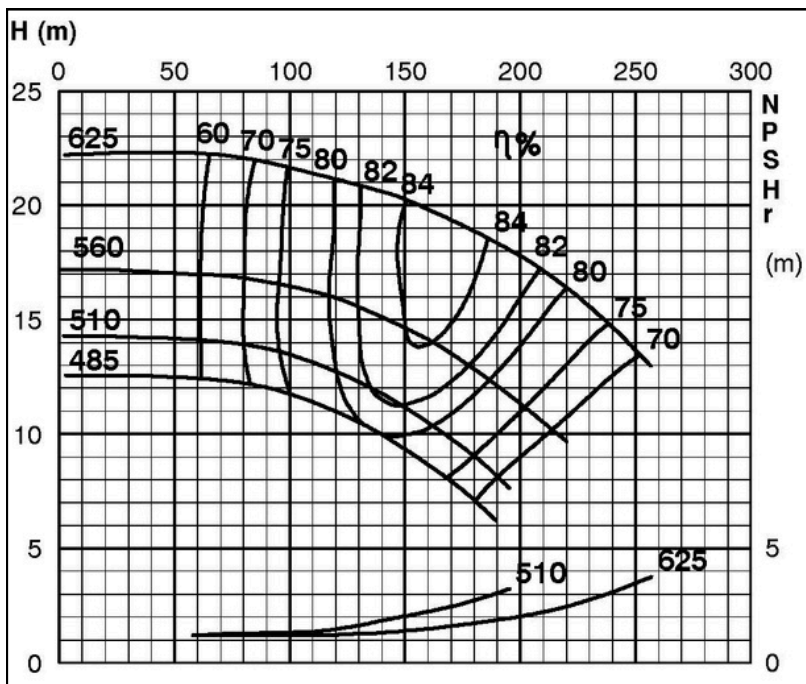

IMPELLER DIA	
$\varnothing d_2$ (mm)	$\varnothing d_b$ (mm)
625	555
620	553
615	550
610	546
605	543
600	542
595	539
590	537
585	534
580	529
575	528
570	525
565	521
560	518
555	516
550	514
545	513
540	512
535	510
530	507
525	504
520	503
515	502
510	497
505	496
500	494
495	493
490	490
485	485

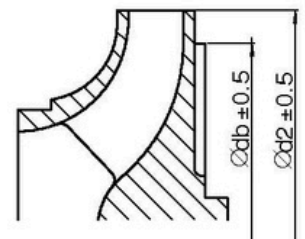
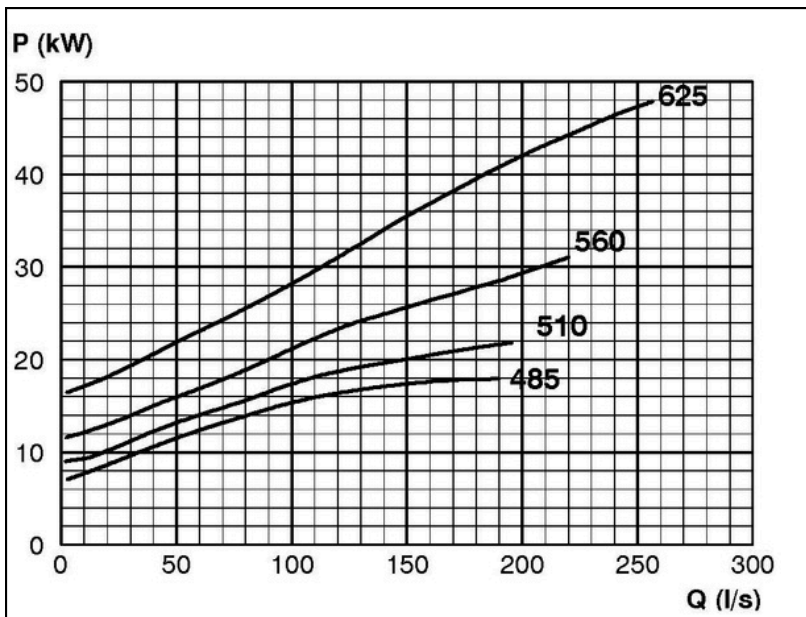

RET4169

TECHNICAL SPECIFICATIONS



ISP Process Pumps - ISP300-600 (400-300-600) ISP Impeller 284006 Closed B61 Z6

Performance Curve - ISP300-600-C-625

625 rpm

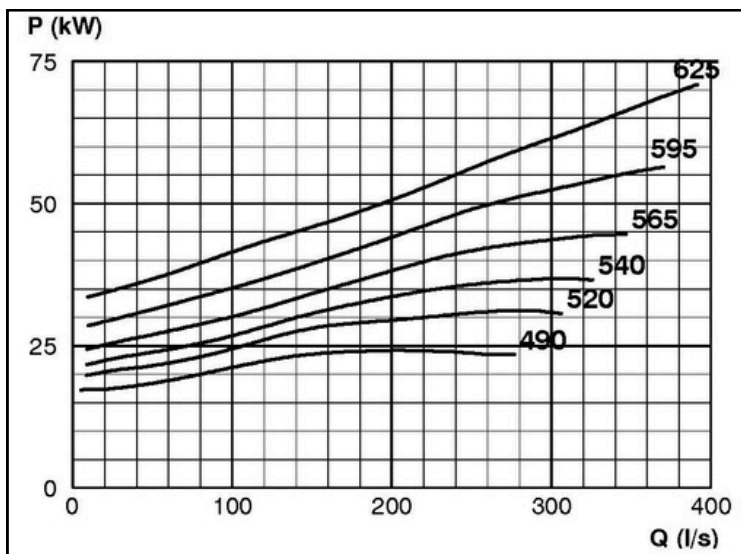
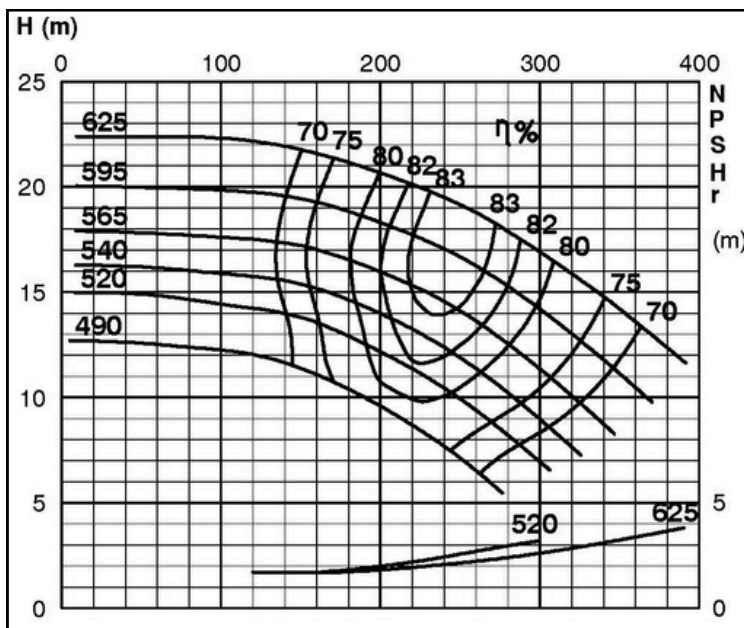

IMPELLER DIA			
∅d ₂ (mm)	K°	∅d _a (mm)	∅d _b (mm)
625			609
620			603
615			598
610			594
605			591
600			587
595			584
590			581
585			576
580			572
575			569
570			566
565			561
560			558
555			555
550			550
545			545
540			540
535			535
530			530
525	1	524	
520	2	515	
515	3	510	
510	4	502	
505	4.5	496	
500	5	489	
495	5.5	483	
490	6	477	

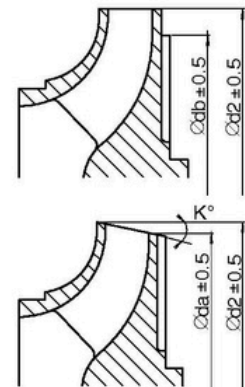

RET4170